



www.enerconind.com/treating

W140 N9572 Fountain Blvd. Menomonee Falls, WI 53051 USA



Getting Started with Corona Surface Treatment

digital book series



Table of Contents

- 1. What does corona treatment do?
- 2. How is corona treatment created?
- 3. Corona Treater Design Options
 - a) Covered Roll/Metal Electrode
 - b) Bare Roll/Ceramic Electrode
 - c) Universal Roll/Ceramic Electrode
- 4. Defining your application requirements
- 5. Next Steps | Contact Enercon

Introduction

Corona treatment is a popular choice for converters and extruders to improve surface adhesion of films.

Extruders use corona treaters when films are created on cast and blown film lines.

Converters use corona treaters to improve adhesion prior to printing, coating and laminating.

This ebook covers the basics of corona treatment and the technologies available for specific application requirements.

Chapter 1

What does corona treatment do?

Converters and extruders use corona treatment to promote wet-out & adhesion of inks, coatings & adhesives.



Corona Treatment increases the surface energy of non-porous surfaces

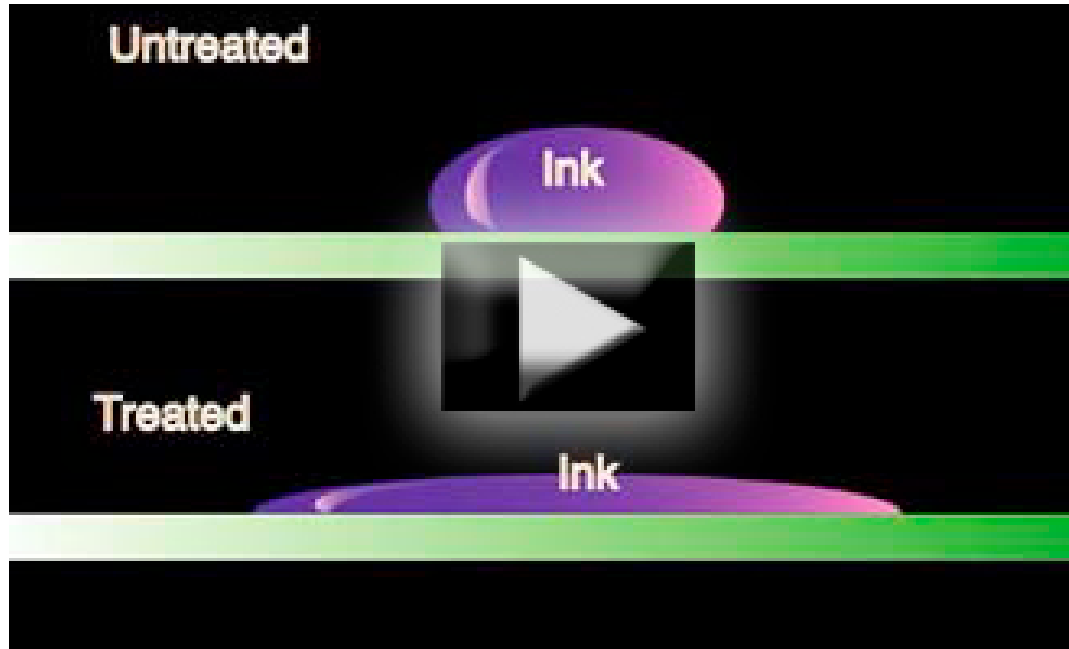

Click the image above to play a description of what a corona treater does.

Polymer films & objects have chemically inert and non-porous surfaces with low surface tensions.

Most often they are non-receptive to bonding with inks, coatings, & adhesives.

Corona treating increases the surface energy of plastic films, foils, paper and polymer objects to **improve wettability & adhesion** of inks, coatings and adhesives.

What happens to a surface during the corona treatment process



Corona treating oxidizes the film surface.

Corona treating forms positive and negative sites by adding and deleting electrons.

These changes increase the energy of a surface.

Surface energy is measured in Dyne Level

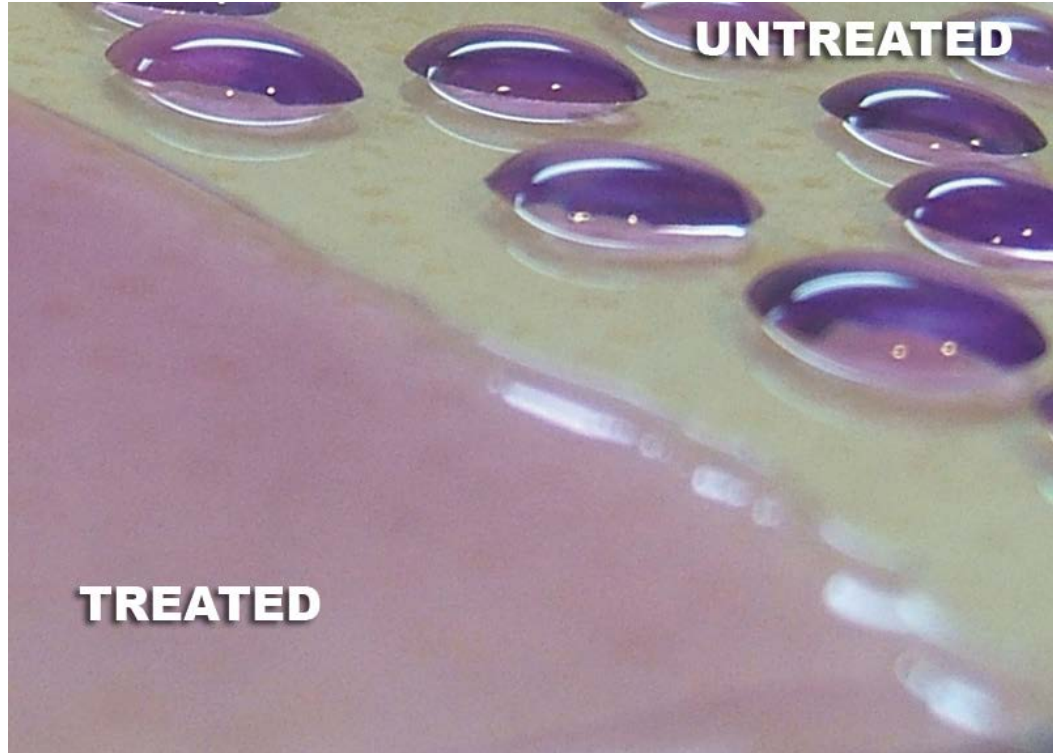

Dynes are a unit of measurement of a surfaces' energy. 1 dyne equals a centimeter-gram-second unit of force.

Dyne solutions & dyne pens are used to measure surface energy.

Generally speaking higher dyne levels produce better adhesion results than lower dyne levels.

Calibrated dyne solution wets out on treated surfaces.

Impact of surface energy on adhesion is significant

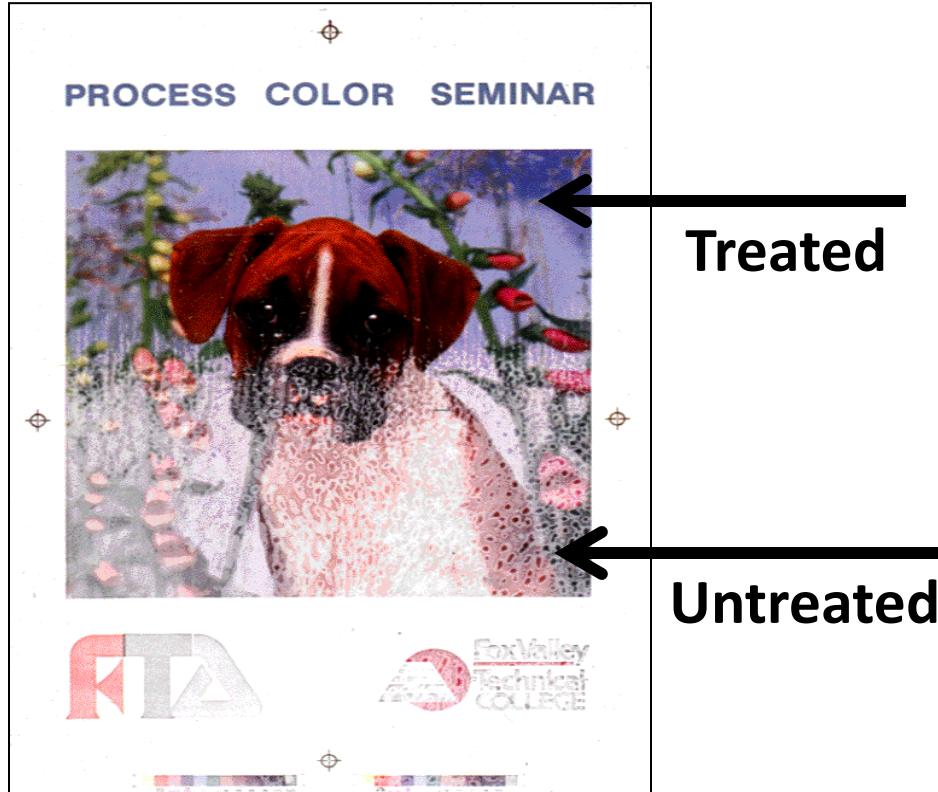

Prior to printing, the upper half of this film was corona treated while the bottom half was not.

The results vividly show **good ink adhesion on the treated areas** & poor ink adhesion on the untreated areas.

Chapter 2

How is corona treatment created?

Corona is created in the air gap between the electrode assembly and ground roll.



Creating corona for the purposes of surface treatment

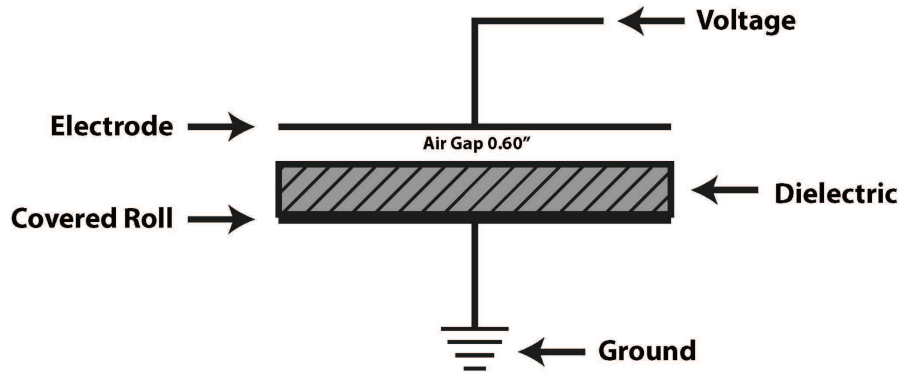

Corona is ionization of air. In its simplest form you can think of a corona treater as a large capacitor.

Voltage is applied to the top plate and the subsequent build up voltage ionizes the air in the gap.

Depending on the corona treater design the dielectric (also know as insulator) will be on the electrode or the ground roll.

Corona treater system components

Power supply



Treater station



High voltage transformer

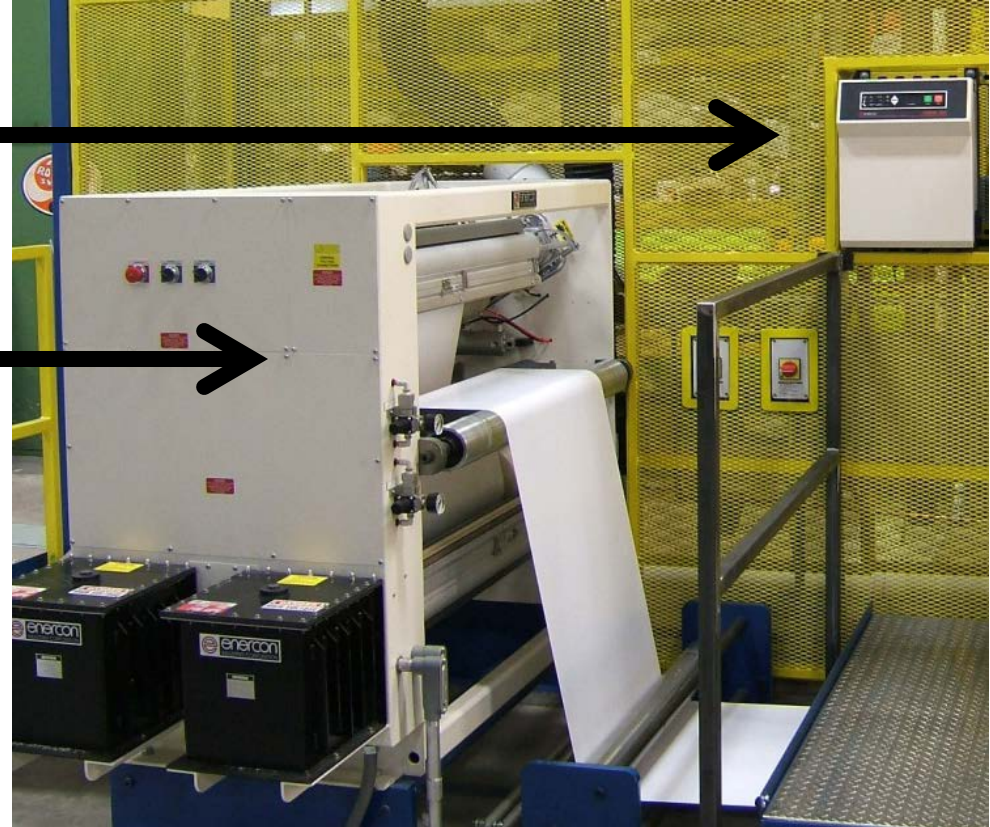
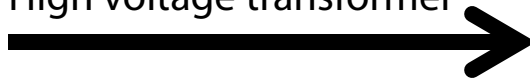

Corona treater system components

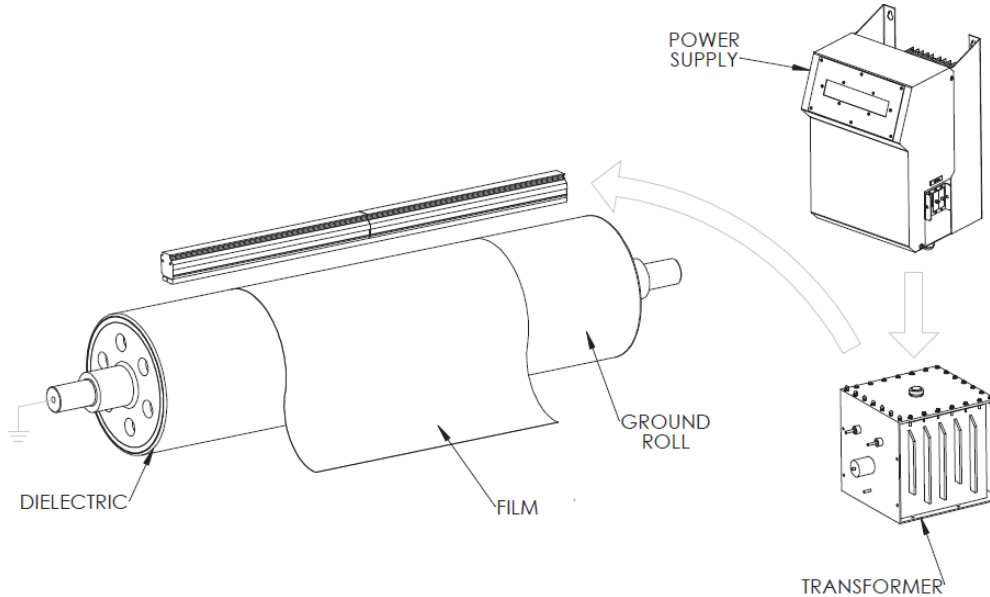

The power supply accepts standard utility electrical power and converts it into single phase, higher frequency (nominally 10 to 30 kHz) power that is supplied to the treater station.

The treater station applies this power to the surface of the material, through an air gap between the electrode and ground roll.

Corona treaters are available in a wide range of widths



Corona treaters are custom engineered pieces of equipment.

Not only are the systems designed with application specific components, corona treaters can also be designed to virtually any width.

The image on the left shows system designs capable of treating narrow tag and label films through ultrawide web systems to 10 meters and beyond.

Chapter 3

Corona Treater Electrode & Roll Options

**Understanding the capabilities of
your corona treater is key to success.**





Ceramic & Metal Electrode Options

Corona Treaters are most easily identified by the type of electrode and roll that are used to generate corona.

Converters primarily use ceramic electrodes for treating conductive and non-conductive films prior to printing, coating and laminating.

Film extruders use either ceramic or metal electrodes for fixed width treatment. For applications requiring lane treatment stainless steel segments are used.

Stainless Steel Electrode Options for Extrusion & Converting



← **Tube**, bar or shoe style for fixed width corona treatment

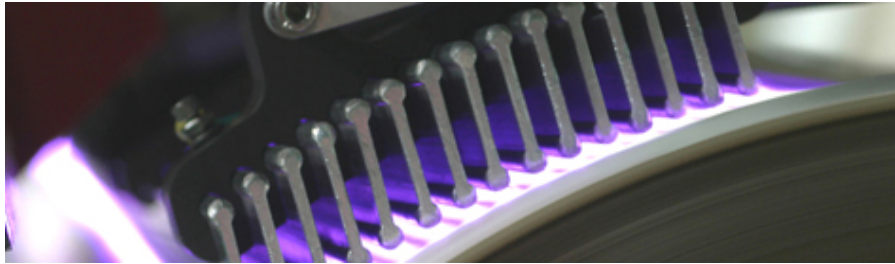

← **Fin** style electrodes for fixed width applications requiring higher power treatment and/or ultra wide film width.

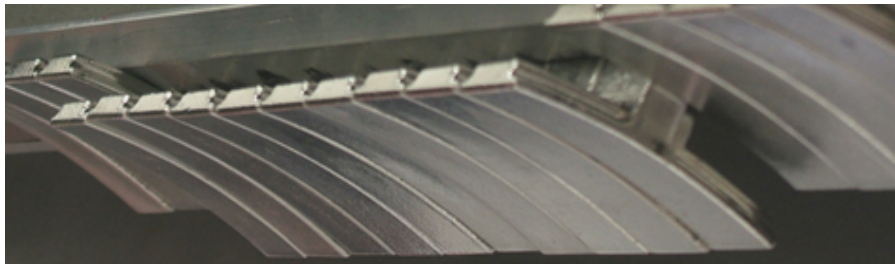

← **Segmented** electrodes are used for applications where lane treating or variable treat width is required.

Note: Metal electrodes can not be used for conductive films



Silicone Sleeve
Covered Roll Station

Roll Coverings for Metal Electrodes

Metal electrodes require ground roll coverings .
The chart below compares popular roll coverings:

Material	Cost	Wear Resistance
Silicone	Low	Basic
Epoxy	Moderate	Good
Ceramic	High	Better
Glass-steel	Very High	Better

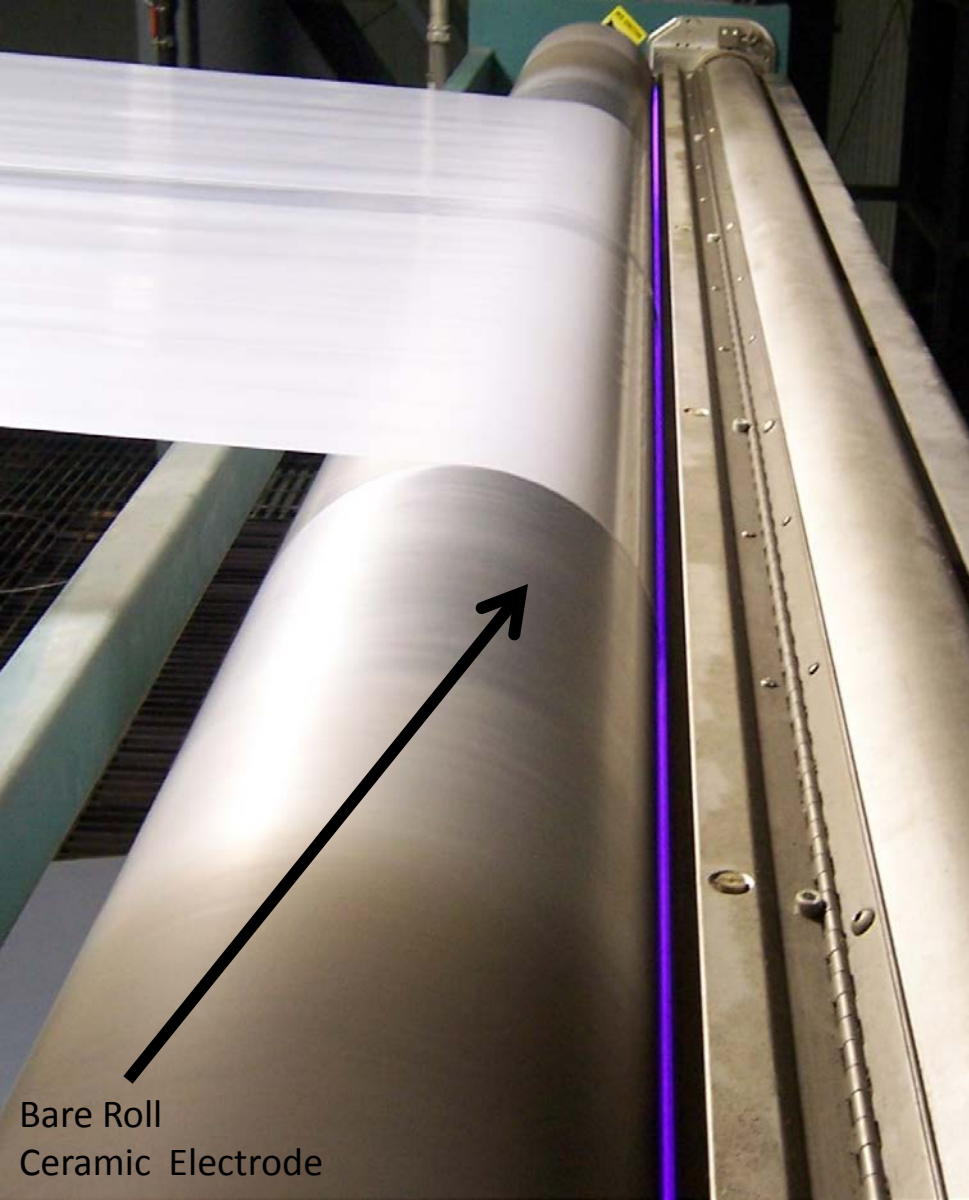

Bare Roll
Ceramic Electrode

Ceramic Electrodes with Bare Roll

Ideal for basic printing, coating, laminating and fixed width extrusion film applications

Can treat any non-conductive films and metallized films and foils.

No roll covering to fail.

Open design allows operators to see corona in operation.

Ceramic Electrodes with Universal Roll Covering

Ordinary Corona with filamentary discharge

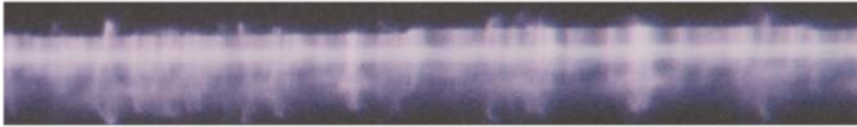

High Definition Corona with uniform discharge



Ideal for all printing, coating, laminating & fixed width extrusion film applications

Proprietary roll covering & high powered electrodes produce **High Definition Corona**

More uniform and higher treatment levels

High power density capability minimizes system foot print

No roll covering to fail

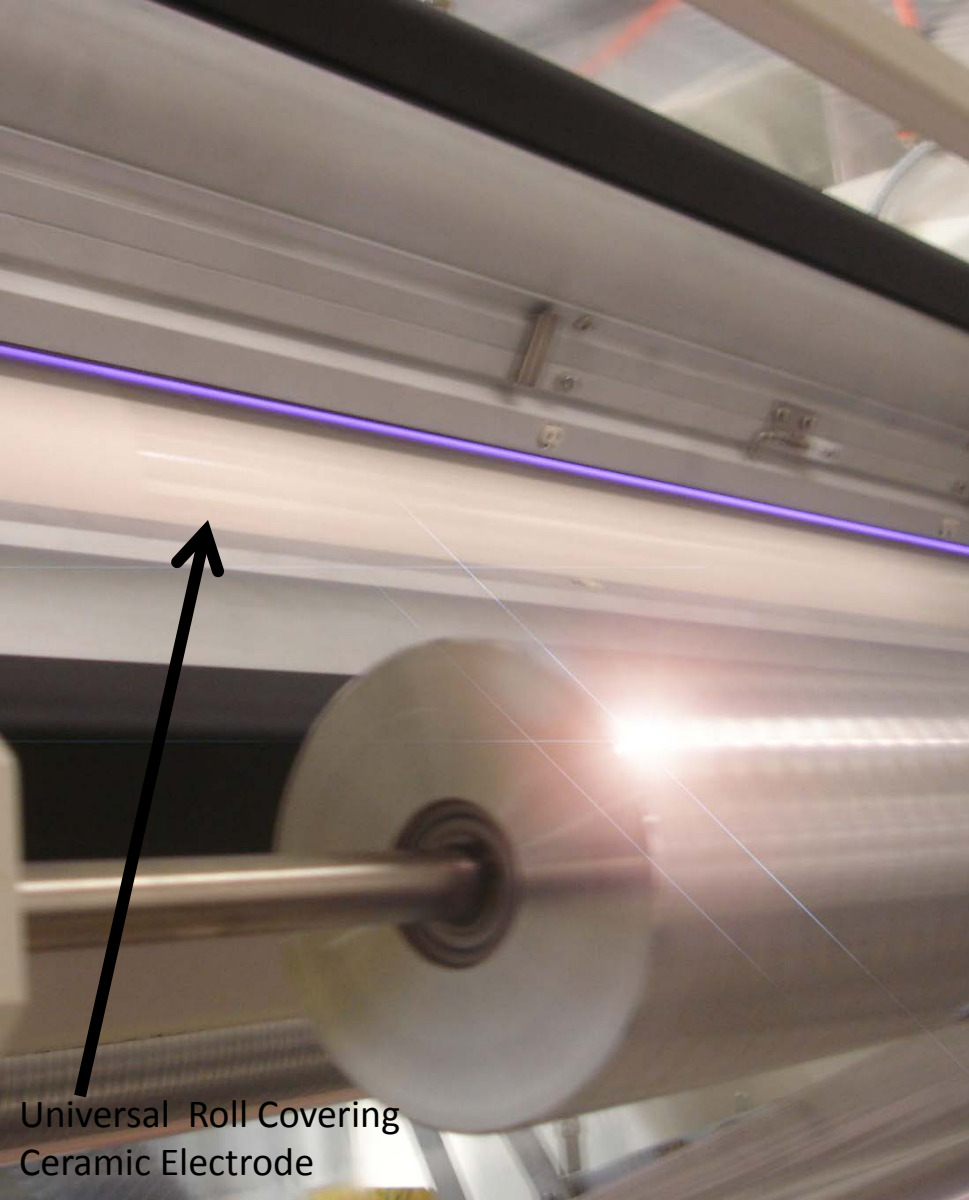

Ceramic Electrodes with Universal Roll Covering

In addition to uniform and high treatment levels this system is a popular choice because it also offers numerous web handling benefits as well.

It offers the best insurance against:

- **backside treatment**
- **pinholing**
- **film wrinkling**

Universal Roll Covering
Ceramic Electrode

Chapter 4

Define your treatment application requirements

A well defined application identifies your best corona treater option.



Application Variables Define your Corona Treater Configuration



There are numerous application variables which need to be considered when selecting a corona treater.

First and foremost, **what process will the corona treater be used?**

- Blown Film
- Cast Film
- Printing (traditional & digital)
- Coating
- Laminating

How will the corona treater be integrated into your line?

Corona treaters can be installed in-line as **free standing units**.

Or mechanically & electrically **integrated with OEM Equipment**.

Application Variables Define your Corona Treater Configuration

Enercon Industries Corporation 10140 N872 Fountain Boulevard #3051 P.O. Box 773 Menomonee Falls, WI 53052-0773
Telephone: (262)255-9070 FAX: (262)255-9774

 **TREATER QUOTE DATA SHEET**

DATE: _____
SALESMAN: _____
PREPARER: _____

CUSTOMER: _____ EXISTING EQUIP? _____

CONTACT: _____ QUOTE THE FOLLOWING:
PHONE NO.: _____ Power Supply Only _____
FAX NO.: _____ Station Only _____
EMAIL: _____ Complete System _____

TYPE OF LINE: _____
PURPOSE OF TREATMENT: _____

SUBSTRATE: LDPE _____ LLDPE _____ HDPE _____ PET _____ FOIL: CLASS A _____
CLASS B _____
PAPER _____ PP _____ METALLIZED: Transfer _____ CLASS C _____
Vacuum _____
OTHER: _____

WHICH SUBSTRATES ARE PRETREATED:
COATING/INK/ADHESIVE: Water-based _____ Solvent-based _____ Extrudate _____
100% Solid _____ Hot Melt _____ UV _____ EG _____

WES WIDTH: _____ IN _____ MM ADDITIVES _____
TREAT WIDTH: _____ IN _____ MM SLIP _____ PPM
ROLL FACE: _____ IN _____ MM TiO₂ _____ PPM
THICKNESS: _____ ANTI-BLOCK _____ PPM
LINE SPEED: _____ FPM _____ MPM COLOR _____ PPM
WEB TENSION: _____ PLI ANTI-STAT _____ PPM
E-STOP WEB TENSION: _____ EVA _____ %
WHICH SIDES TO TREAT: _____ OTHER _____ PPM
TREAT LEVEL: (Dynes) _____
OR
WATT DENSITY: (Watts/ft²/Min) _____

MOUNTING LOCATION: _____

SWITCHING OPTION: Low Voltage _____ High Voltage _____ None _____

HAZARDOUS LOCATION: YES _____ QUOTE AS OPTION _____ OR WITH SYSTEM _____
NO _____

SPECIAL REQUESTS/COMMENTS: _____

Important Application Variables

- Types of film being treated
 - Known additives & slip agents
- Number of sides being treated
- Speed of line
- Goal of treatment/power required
- Web Treatment requirements
 - Lane/ Skip/ Pattern
- Does the roll need to be driven
- Nip rolls required
- Expectations for value and performance of roll coverings

Chapter 5

Getting Started... Review & Next Steps

Specifying the right corona treater is key to maximizing results.



Keys to getting started with corona surface treatment



Corona is ionized air created in an air gap between an electrode and ground roll.

Corona treatment is used to increase the wettability of a film's surface to improve printing, coating & laminating adhesion.

Corona treaters are available with either metal or ceramic electrodes with various roll covering options.

Take advantage of laboratory trials to ensure your success



Defining your application will guide you in selecting the best corona treater for your application.

You may also find benefits in utilizing Enercon's surface treating laboratory to conduct corona, flame and atmospheric plasma lab trials.



[Click to learn more about Enercon Lab Trials](#)

Enercon's surface treating laboratory is equipped with all corona treating technologies as well as plasma & flame treating systems.

Innovative People. Ensuring your treating success.



enercon
INDUSTRIES CORPORATION

Surface Treating. It's our passion.

And, we'd love to help you with your get started with your next project.

Take advantage of our reliable technology, decades of application expertise and steadfast commitment to your success.

Learn more about corona, plasma, flame and ozone surface treating solutions by contacting us today.



Contact an application expert.
Click or call 1-262 255-6070

Global perspective and Local support from a world leader



Since 1974 Enercon has brought innovative and cost-effective solutions to manufacturers.

Our team is committed to your success & will provide you the finest application expertise & product support.

We invite you to consult with us on your next project.



Enercon's global operations are supported by an international network of equipment and application expert who provide you with global perspective and local support.